

ELE2055065

2.073 Kg/m

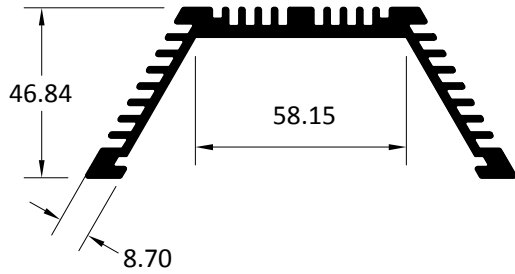

ELE1055157

1.092 Kg/m

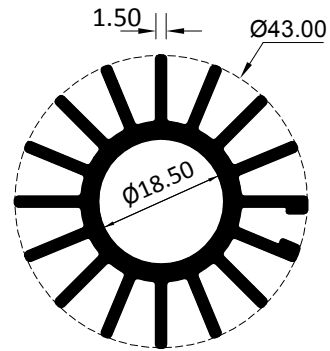

ELE1055139

1.622 Kg/m

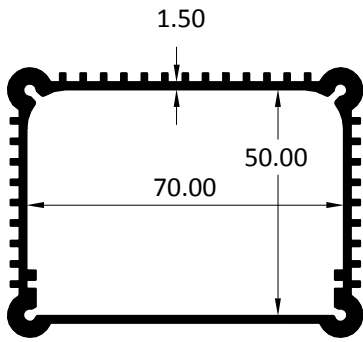

ELE1055225

1.118 Kg/m

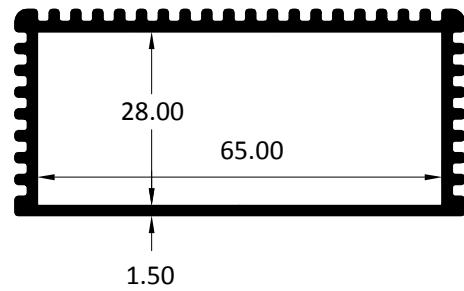

ELE2055071

3.416 Kg/m

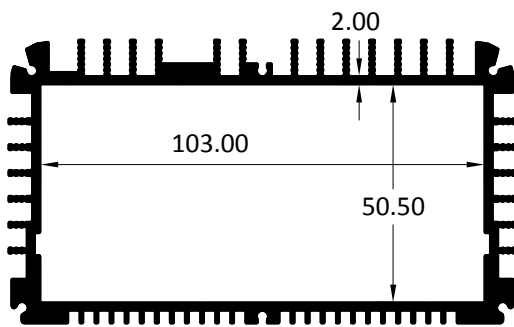

ELE3055303

5.309 Kg/m

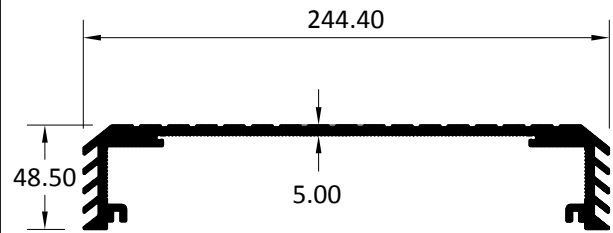

ELE1055302

0.499 Kg/m

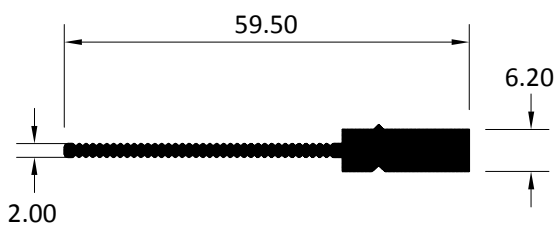

ELE2055317

5.418 Kg/m

